

Conveyor Belt - Pull Rope Switch

Model: IS-RPT-I



OVERVIEWS

Pull Rope Switch is a protection switch used for emergency stop of belt conveyor. When an emergency occurs on the belt conveyor, the staff can start the pull rope switch at any position along the conveyor and stop the belt immediately to prevent the expansion of the accident. The devices are suitable for outdoor use and applications where the ambient temperature varies considerably.

With the pull-rope system functionally aligned, the emergency stop signal can be triggered over a distance of up to about 60m for each switch.

This product is easy to install, reliable performance, it is widely used in the field of belt conveyor.

CHARACTERISTIC

- Adopt high-strength Aluminum-alloy precise die-casting shell, with strong impact resistant capability
- High protective degree of shell, good sealing property.
- Single switching output, large contact capacity, sensitive action and reliable performance
- Plastic coated steel wire rope moisture proof, acid and alkali resistant, flame retardant

TECHNICAL DATA

Ambient temperature	-30°C~ 60°C	Number of contacts	1NO 1NC
Relative humidity	0 ~ 85%	Action force	70~ 100N
Atmospheric pressure	80 kPa ~110kPa	Adjustment range	20°~ 30°
Electrical life	>100,000 times	Limit angle	60°
Output mode and quantity	2×SPDT	Reset mode	Manual
Contact rating	AC380V 5A - DC24V 5A	Protection level	IP65

INSTALLATION DIAGRAM

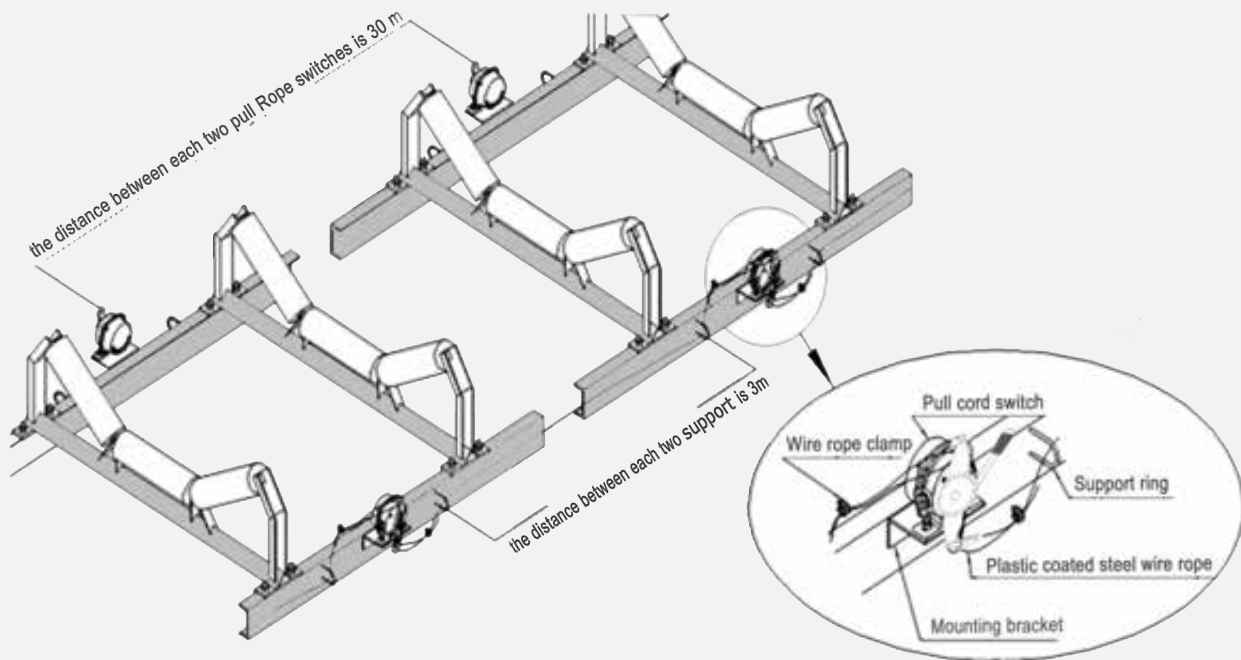

ACCESSORIES

Plastic coated steel wire rope



Mounting bracket

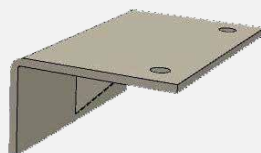

Support ring



Wire rope clamp



Fastener



DIMENSION

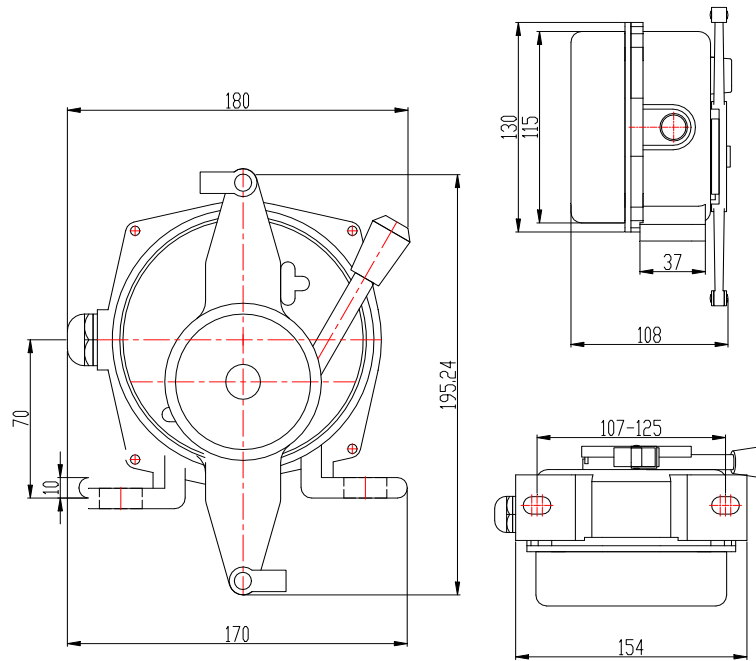

INSTALLATION STEPS

1) Fix the mounting bracket on the belt conveyor frame as shown in the figure below, and then install the pull cord switch on the bracket with fasteners.

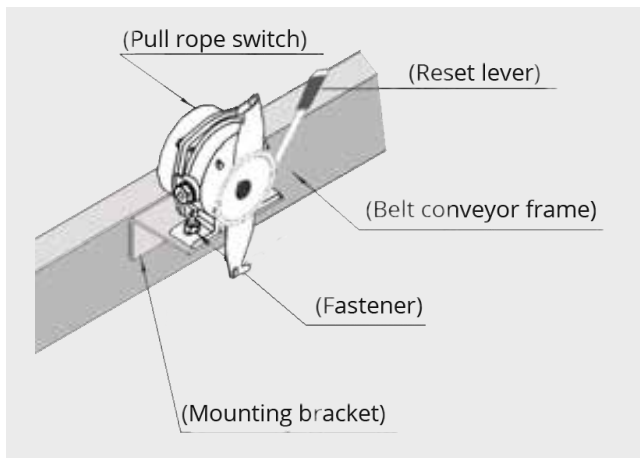

2) The plastic coated steel wire rope is connected to the swing arm of the pull cord switch and fixed with the wire rope clamp, Ensure the pull cord action is reliable. Under the premise of satisfying the normal operation of the switch, tighten the rope as much as possible to reduce the droop caused by the dead weight of the wire rope.

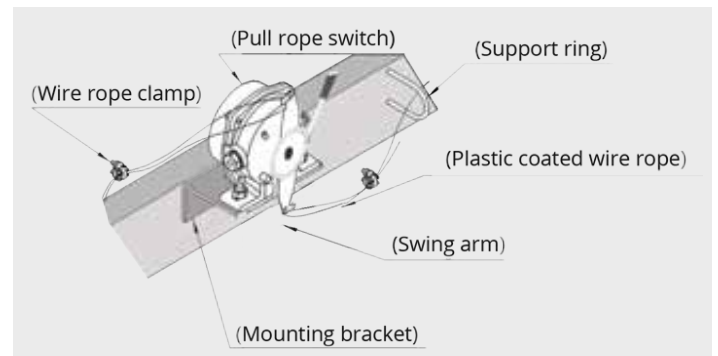

3) In order to reduce the influence of the dead weight of the wire rope on the switch starting, weld a support ring on the frame every 3 meters to support the wire rope.

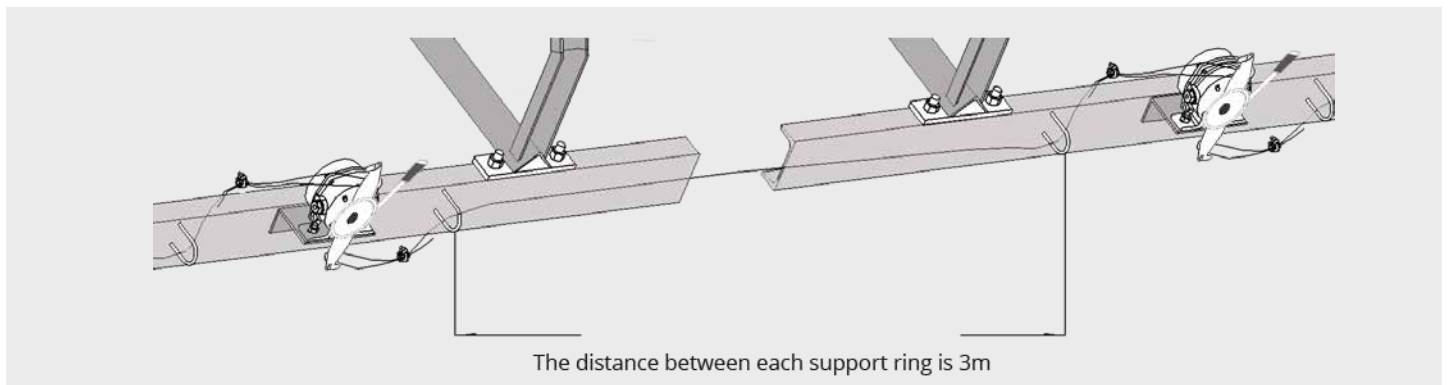

Note: The pull rope switch is installed on both sides of the frame along the belt conveyor. The distance between the two switches is 30 meters. The switching distance of the belt conveyor with slope should be shortened as appropriate.

WIRING DIAGRAM

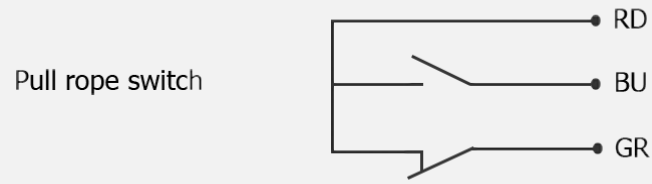

Pull rope switch wiring principle diagram

WORKING PRINCIPLE

When an emergency occurs of the belt conveyor, the staff can pull the wire rope attached to the switch, and the wire rope can drive the swing arm to rotate, so that the stroke switch in the cable switch can act and send out the stop signal. This switch is manual reset mode. After troubleshooting, push the reset lever to reset

